

HAND TELEPHONE SETS—200 SERIES

IDENTIFICATION AND ASSEMBLY OF PARTS

1.00 INTRODUCTION

This section covers the identification and assembly of parts of the 200 series hand telephone sets.

2.00 GENERAL

2.01 The 200 series hand telephone sets are equipped with C-, D-, and G-type handset mountings. They are used with either induction coil or network-type subscriber sets in manual or dial areas, and also with magneto-type subscriber sets.

2.02 For information on class of service, refer to the C Section entitled Station Sets, Common Battery, Selection for General Use.

2.03 Cording for hand telephone sets will not be covered in detail. However, cording should be done in a manner which will eliminate the possibility of the cord conductors coming in contact with any moving part, or making electrical contact with any terminal other than the one for which it is intended. Cord anchoring devices will be shown in this section.

2.04 The positioning of the dial on C- and G-type handset mountings is described in the C Section entitled Station Sets, Installation.

3.00 IDENTIFICATION

The hand telephone set consists of a mounting, handset, apparatus blank or dial, mounting cord, and handset cord. The code marking for the mounting is stamped on the exterior of the mounting.

4.00 DESK-TYPE HAND TELEPHONE SETS

Desk-type hand telephone sets include types 202, 203, 204, 206, 207, and 215. Fig. 1 and 2 show the manual and dial desk-type hand telephone sets with the D-type mounting (oval base). The earlier B-type mounting (round base) is not shown. Fig. 3 shows the oval base of the D-type mounting with felt and friction pads.

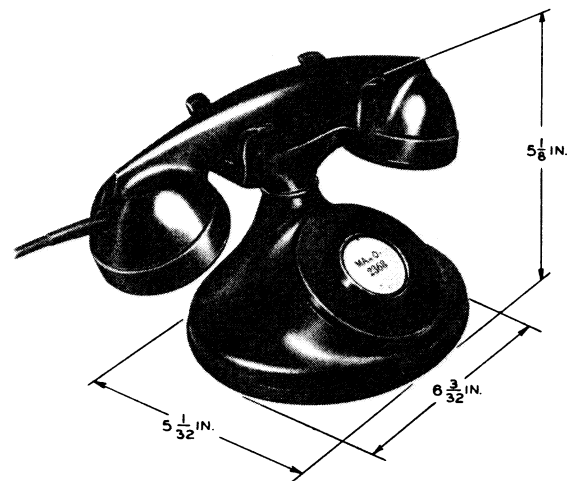

Fig. 1 — Manual Desk-type Set

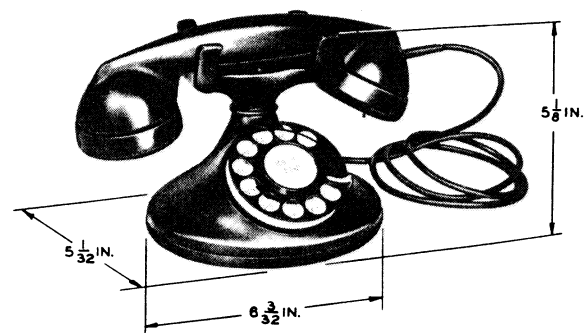

Fig. 2 — Dial Desk-type Set

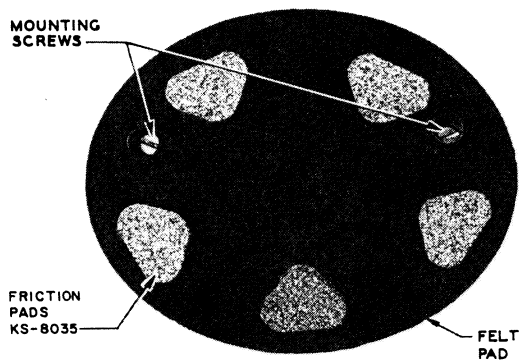

Fig. 3 — Oval Base D-type Handset Mounting

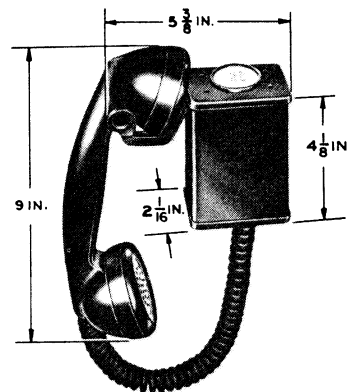

Fig. 4 — Manual Hang-up C-type Set

5.00 HANG-UP TYPE HAND TELEPHONE SETS

5.01 The hang-up hand telephone sets include types 201, 211, 212, 213, and 214 and utilize the C- and G-type mountings.

5.02 The C-type mounting shown in Fig. 4 and 5 provides rotating adjustment to position the dial with respect to the user. The G-type mounting shown in Fig. 7 provides both rotating and tilting adjustments for positioning the dial.

5.03 The C handset mounting is equipped with a bracket for attaching the mounting, and it will permit adjustment of the mounting to various lengths of desk top overhang. The bracket for the G-type mounting serves the same purpose and, in addition, permits the handset to be hung from either the front or side of the mounting.

5.04 The 211J, 211L, and 212L hang-up hand telephone sets, equipped with the G-type mounting and G-type handset, are furnished with a chromium plated handset hook, but otherwise are similar in external appearance to the hand telephone sets shown in Fig. 6 and 7. These hand telephone sets are designed to be used with the 685- and 686-type subscriber sets.

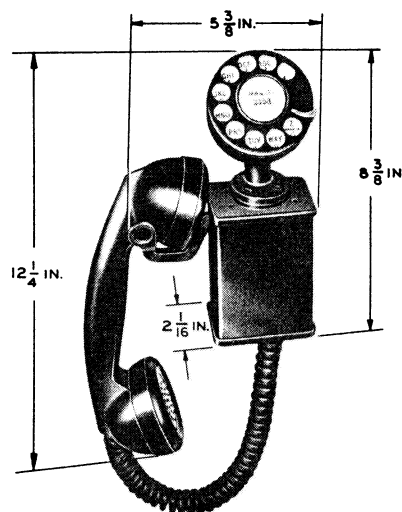

Fig. 5 — Dial Hang-up C-type Set

6.00 ASSEMBLY OF PARTS

D-type Handset Mounting

6.01 The D-type handset mounting is normally used with types 202, 203, 206, 207, and 215 hand telephone sets (see Fig. 8 and 9).

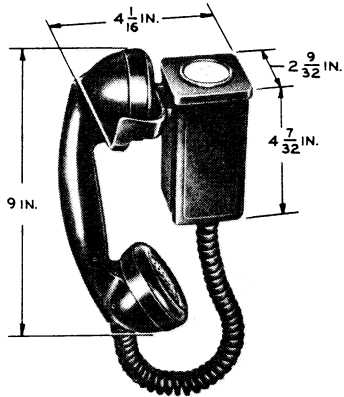

Fig. 6 — Manual Hang-up G-type Set

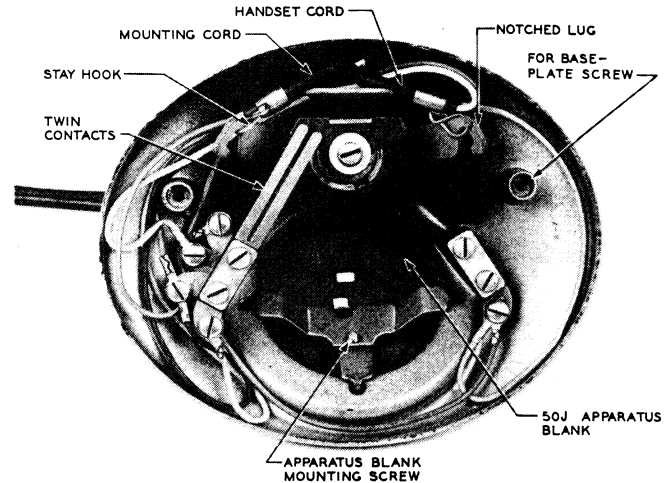

Fig. 8 — Assembly of D-type Handset Mounting (Manual)

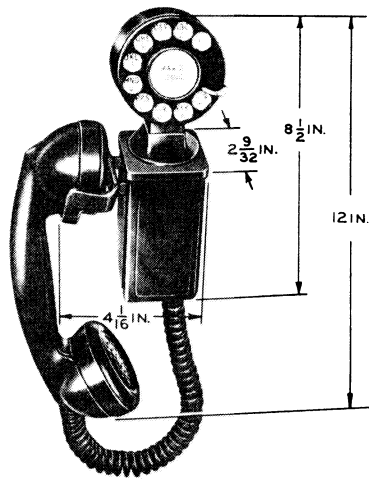

Fig. 7 — Dial Hang-up G-type Set

6.02 When required, the 61N filter is used with the D-type handset mounting. When mounting a filter in a D-type handset mounting that is equipped with a 6-type dial, the dust cover must be removed from the dial and left off.

6.03 When replacing the plunger, the nickel-silver guides should be on the right side viewed from the front of the handset mounting.

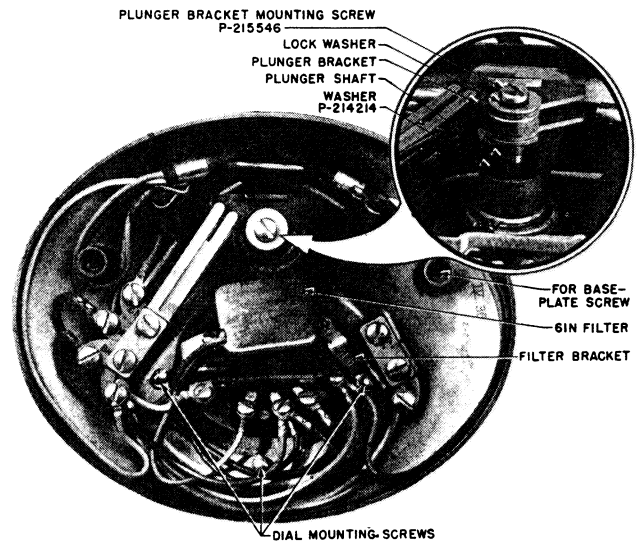

Fig. 9 — Assembly of Filter on D-type Handset Mounting (Dial)

Care should be exercised that the plunger stem is properly seated in the plunger bracket before the plunger bracket mounting screw is tightened (see Fig. 10).

PORTIONS OF THIS PAPER DOCUMENT PAGE WERE MISSING

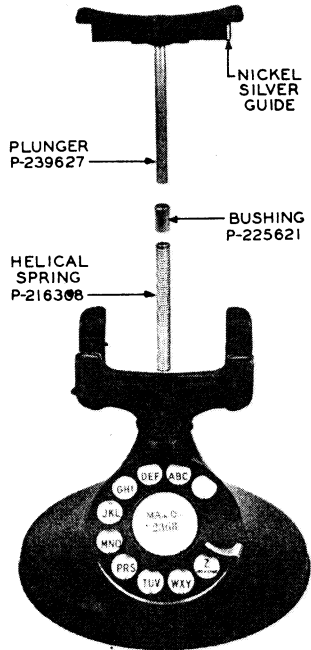

Fig. 10 — Assembly of Plunger on D-type Handset Mounting

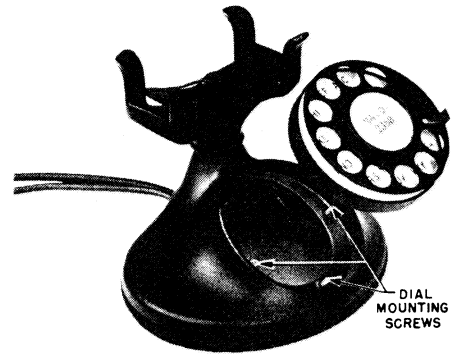

Fig. 11 — Assembly of Dial on D-type Handset Mounting

04 The D-type handset mounting may be equipped with a 4-, 5-, or 6-type dial. The top cover must be removed from the 6-type dial when used with the D-type handset mounting (see Fig. 11).

05 Care should be exercised in connecting conductors to terminal R of 4- and 5-type dials and terminal W of 6-type dials to be certain that the lead tips do not come in contact with the adjacent dial mounting screw or the flange of the handset mounting.

C-type Handset Mounting

06 The C-type handset mounting is used with the 201 hang-up type hand telephone set (see Fig. 12 and 13).

07 When required, the 61G filter is used with the C-type handset mounting (see Fig. 14 and 15).

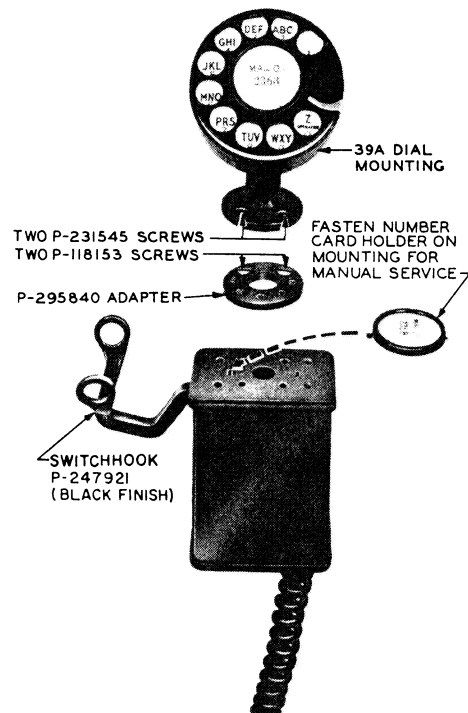
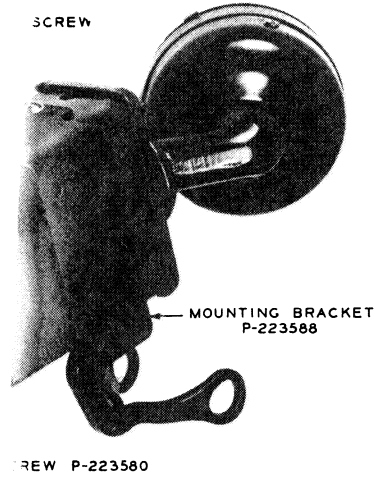
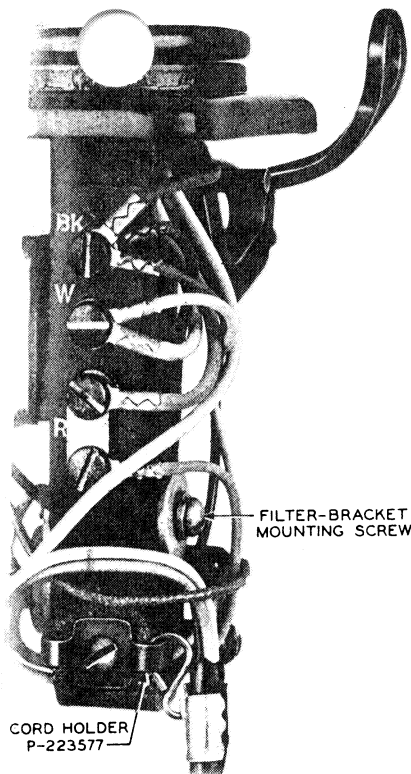

Fig. 12 — Assembly of 39A Dial Mounting on C-type Handset Mounting

PORTIONS OF THIS PAPER DOCUMENT PAGE WERE MISSING



Assembly of C-type Handset Mounting Bracket



Assembly of Filter on C-type Handset Mounting

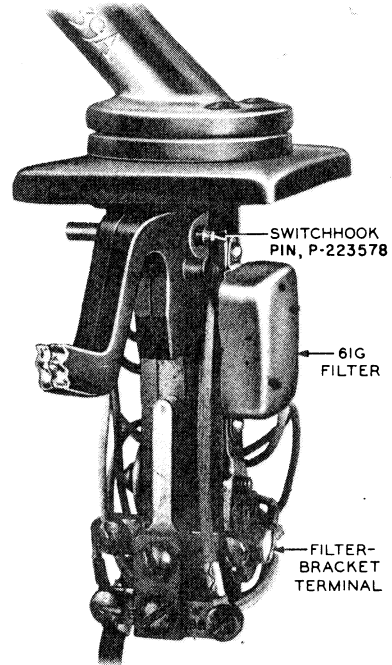

Fig. 15 — Assembly of Switchhook on C-type Handset Mounting

G-type Handset Mounting

6.08 The G-type handset mounting is used with the 211-, 212-, and 213-hang-up type hand telephone sets (see Fig. 16 and 17). The earlier 41A dial mounting is secured in the same manner as shown for the 43A.

6.09 When required, the 61M filter is used with the G-type handset mounting (see Fig. 18). The helical spring should be removed before the switchhook pin is extracted (see Fig. 19).

6.10 The cord holder on the G6 and G7 handset mountings will enable handset cords equipped with either an S hook or stayhook to be terminated (see Fig. 21).

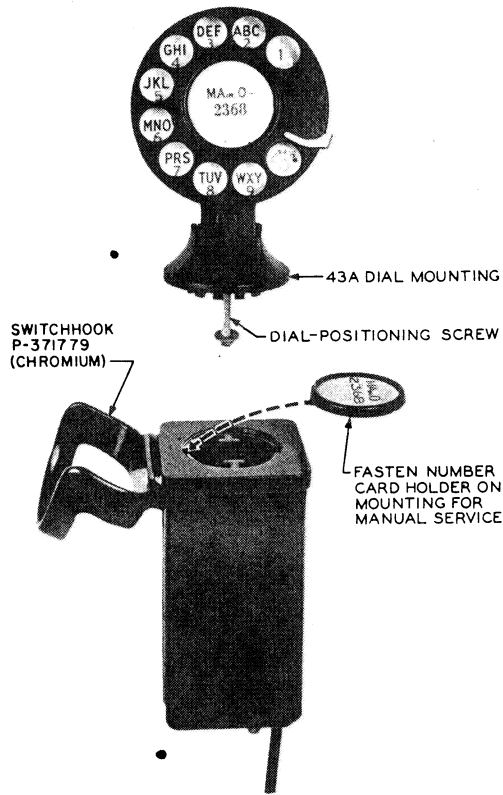

Fig. 16 — Assembly of 43A Dial Mounting on G-type Handset Mounting

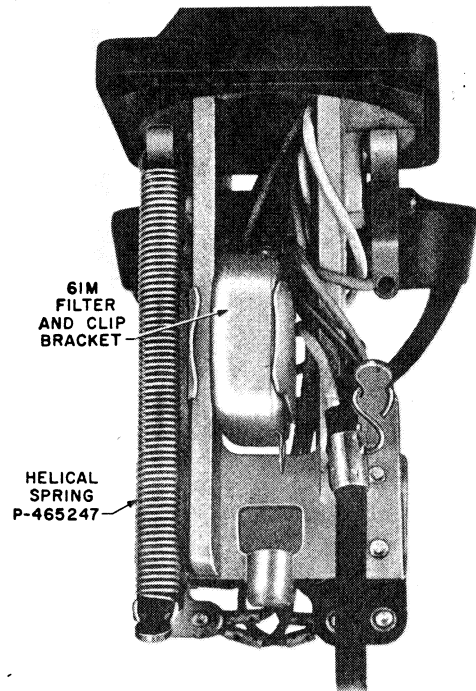

Fig. 18 — Assembly of Filter on G-type Handset Mounting

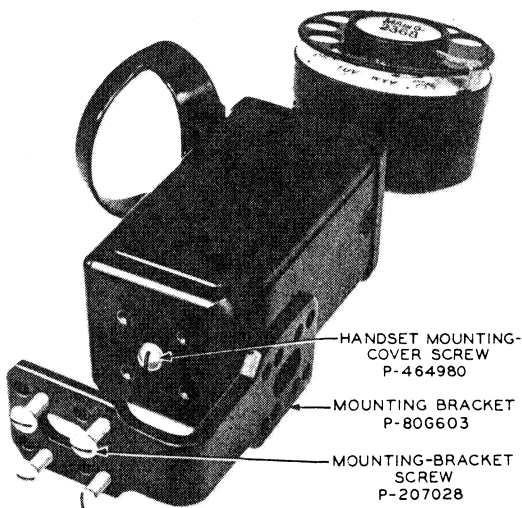

Fig. 17 — Assembly of G-type Handset Mounting and Bracket

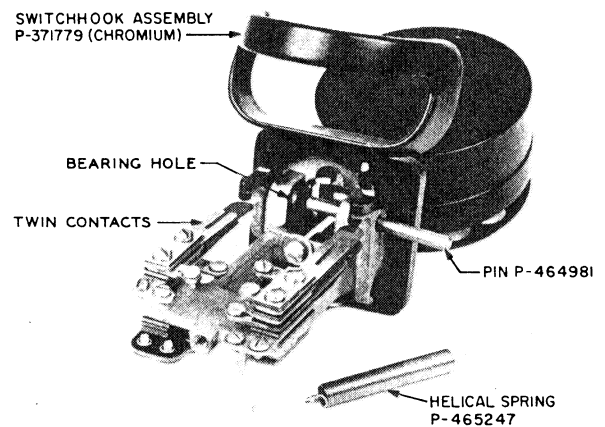

Fig. 19 — G-type Handset Mounting Switchhook Assembly

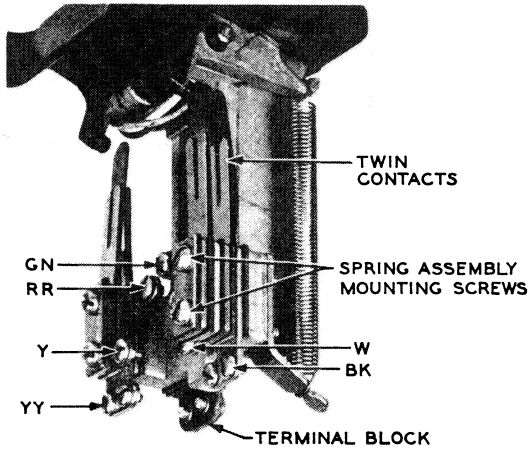

Fig. 20 - G-type Handset Mounting Spring Combination

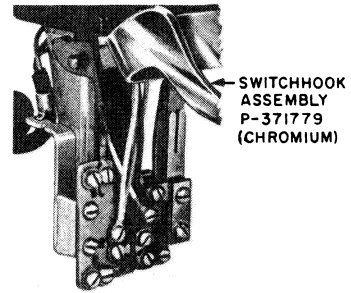

Fig. 21 - Cord Holder on G6 or G7 Handset Mounting

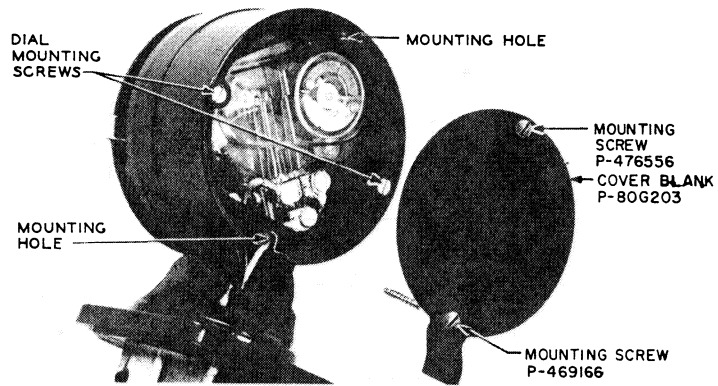

Fig. 22 - G-type Handset Mounting, Rear View

7.00 COMPONENTS

7.01 The component parts of the desk-type hand telephone sets are shown in Table A.

7.02 The component parts of the hang-up type hand telephone sets are shown in Table B.

7.03 Hang-up type hand telephone sets in color are shown in Table C.

TABLE A

Coded Components	Desk-type Hand Telephone Sets															
	202 A	202 B, C, D	202 E, F, G	202 / H	203 A, B, C	203 D, E, F	204 A	204 B, C, D	206 A	206 B, C, D	206 J, K, L	206 M, N, P	207 A	207 B, C, D	215 A	215 B, C, D
Handset Mounting	D1-3	•	•	•												
	D3-3					•							•			
	D5-3							•								
	D6-3				•											
	D8-3														•	
	D10-3											•				
Apparatus Blank	50J-3	•		•					•					•		
	94A-3	*		*				*					*			
Dial	5H Type		•	•	•	•	•	•	•	•	•	•	•	•	•	•
	6A		*	*	*	*	*	*	*	*	*	*	*	*	*	*
Handset	FIG-3	•	•	•	•	•	•	•	•	•	•	•	•	•	•	•
	F2B-3										•			•		

Note: Hand telephone sets having F-type handsets are coded with the letter F after the color designation number, as for example, 202A-3F. Sets having a handset with a spring cord have the letter R included in the code, as for example, 202AR-3F.

* When more than one code of apparatus or piece part is listed as suitable for replacement purposes in Table A and local stock on any of these is not available, order that part which has the asterisk.



TABLE B

Coded Components	Hang-up Type Hand Telephone Sets																					
	201 A	201 B, C, D	201 A, E	201 B, C, D	211 F, G, H	211 J	211 JR	211 L	211 LR	211 MR	211 N	211 NR	211 P	211 PR	212 A, B, C	212 L	212 LR	212 MR	213 A, B, C	213 E	214 A, B, C, D	
C1-3	•																					
G1-3		•			•																	
G2-3															•						•	
G3-3																					•	
G6-3						•		•	•													
G7-3																•		•				•
G8-3											•	•	•	•								
39-A-3		•																				
41-A				•	•																•	•
42-A				*	*			•	•	•		•	•	•	*	•	•	•	*			*
5H Type		•		•	•										•							•
6A		*		*	*										*				*			*
6D-3							•		•	•						•	•	•				
6J-3													•	•								
F1G-3	•	•	•	•	•										•				•	•		
F2B-3																					•	•
G3A-3						•		•			•					•						
G3AR-3									•	•	•			•			•					•

Note: Hand telephone sets having F-type handsets are coded with the letter F after the color designation number, as for example, 201A-3F. Sets having a handset with a spring cord have the letter R included in the code, as for example, 201AR-3F.

* When more than one code of apparatus or piece part is listed as suitable for replacement purposes in Table B and local stock on any of these is not available, order that part which has the asterisk.

TABLE C

Coded Components	Hang-up Type Hand Telephone Sets			
	211JR	211LR	211NR	211PR
Ivory-50	•	•	•	•
Green-51	•	•	•	•
Gray-52				
Red-53	•	•	•	•
Brown-54			•	•
Beige-55				
Yellow-56	•	•	•	•
Blue-57				
White-58	•	•	•	•
Rose Pink-59	•	•	•	•
Light Beige-60	•	•	•	•
Light Gray-61	•	•	•	•
Aqua Blue-62	•	•	•	•